



OxBlue

part of Hexagon

VISUALIZE

retail projects with ease

A person in a blue shirt is working at a desk. They are holding a tablet in their left hand and a pen in their right hand, writing on a document. A laptop is open in front of them. The background is a window with a view of a city skyline. The overall tone is professional and focused.

Oversee Multiple Retail Projects

with OxBlue construction cameras for collaboration, documentation and clear communication

Our HD cameras provide real-time monitoring for major chains, general contractors and developers to manage changing conditions on the jobsite.

Access projects on demand, review site history and instantly generate marketing time-lapses through one web-app. By combining static images, live video feeds and artificial intelligence, construction webcams make it easy to support anyone's need to understand jobsite progress.



Big Box Store

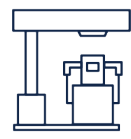

Gas Station

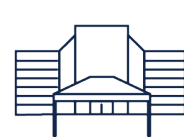

Mall



Open Store Remodel



Outparcel Store



Restuarant



Street Side Shop



Shopping Center



Shop-in-Shop

Construction Cameras That Work For Leading Retail Companies



OxBlue, part of Hexagon, is a leading global provider of construction time-lapse and live streaming video camera services. Founded in 2001 and based in Atlanta, Georgia, OxBlue has been present on nearly 30,000 job sites and worked with more than 5,900 clients across all industries.

Pricing And Plan Options Tailored To Your Jobsite



Standard

Pay only for the days you use, no contract



Contract

Set a fixed annual or monthly payment



Prepaid

Set your budget without a contract



Enterprise

Custom options for large corporations



DOLLAR TREE



Trusted by industry leaders across all markets



Oversee successful store development from anywhere

Every project requires three fundamental components to build success:

- Clear communication
- Visibility on the jobsite
- Efficient resource management

Construction cameras deliver these results by providing real-time visuals and straightforward access to what's happening on site. Images and video make it clear where things are on track or falling behind schedule, helping determine if a site visit is necessary.

MANAGE

“By viewing the job site in real time, we can verify work in place, identify any performance issues, and have more visibility to things we could possibly do differently.”

— RaceTrac

With the OxBlue Interface, it's easy to increase communication with one-click sharing features, remote access to the jobsite and user controls that allow for a closer look.

OxBlue construction cameras also have tools that help highlight patterns and team actions. Using the advanced capabilities of the camera, it's easy to detail performance in new ways. Weekly Activity Analysis can show who routinely sticks to schedule and premium analytics can emphasize a team's ability to adjust to unexpected interruptions. All of this important information gives a detailed look at what's been done and what clients can expect to see.

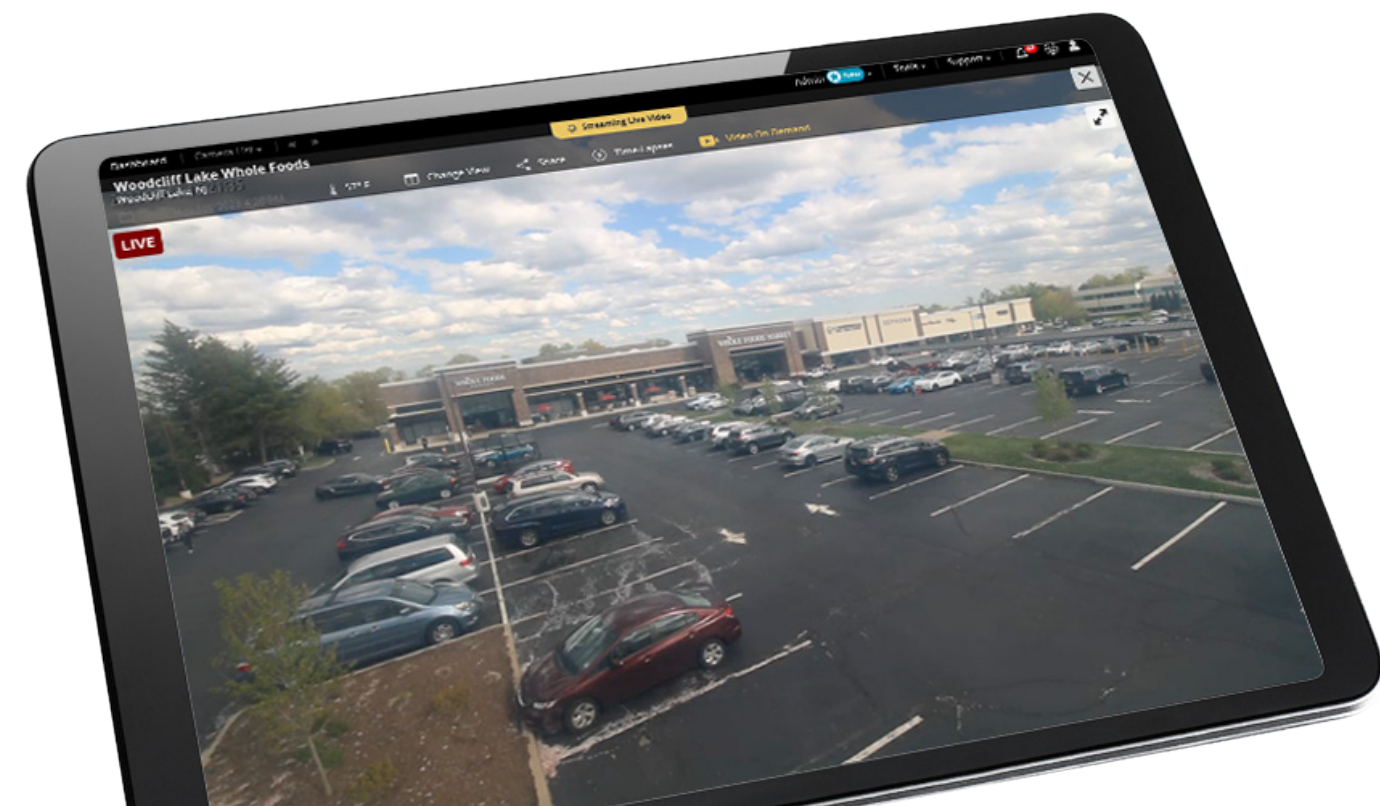

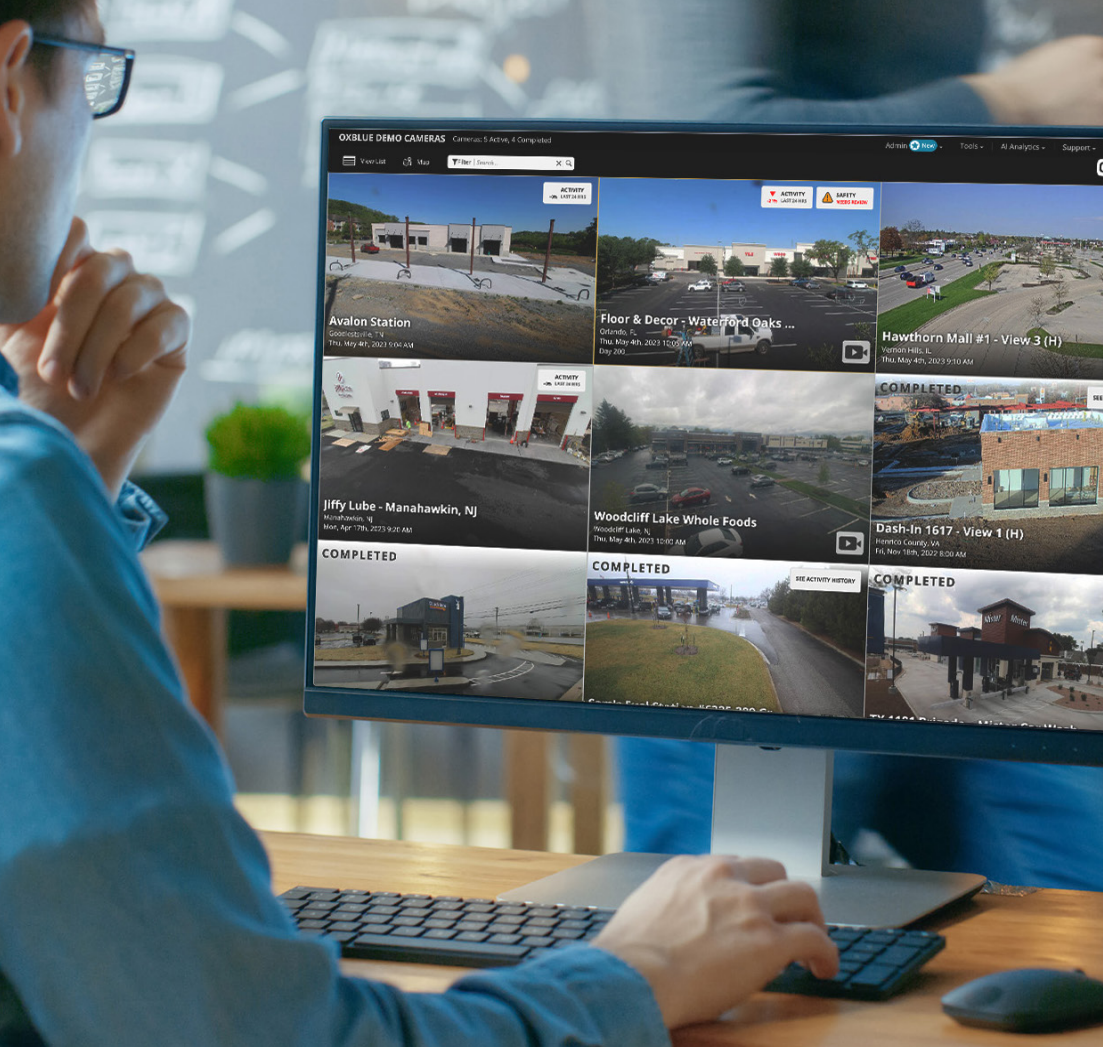

Monitor Jobsites Simultaneously
See all your projects in one dashboard view or sort by location to monitor multiple sites simultaneously.

View Progress Remotely
Access the jobsite on any device at any time using video on demand or live streaming.



Schedule Updates
Define a schedule to routinely send images and/or time-lapse videos to yourself or others.

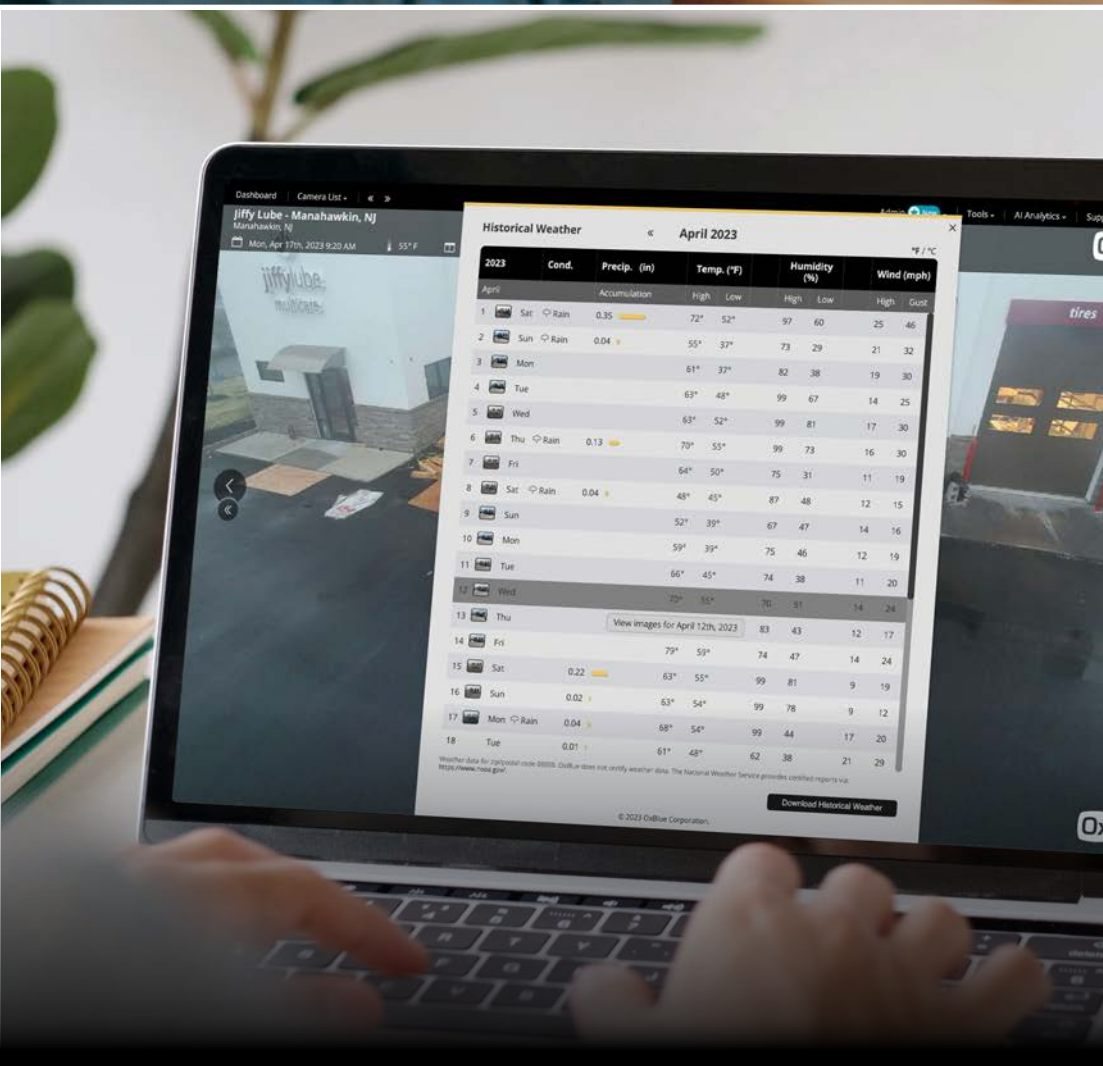

Monitor Weather Impact
Quickly see if weather conditions have impacted progress or performance with a grid that highlights precipitation, humidity, wind and temperatures.

Equipment Notifications
Track movement of 11 different types of equipment on site





Activity Analysis
 Compare jobsite activity with weather events to ensure teams are maintaining schedules and working at peak performance levels.



Safety Tracking
 Watch the jobsite in real-time and ensure safety compliance levels across projects. OxBlue's AI looks for standard PPE compliance and highlights potential issues.

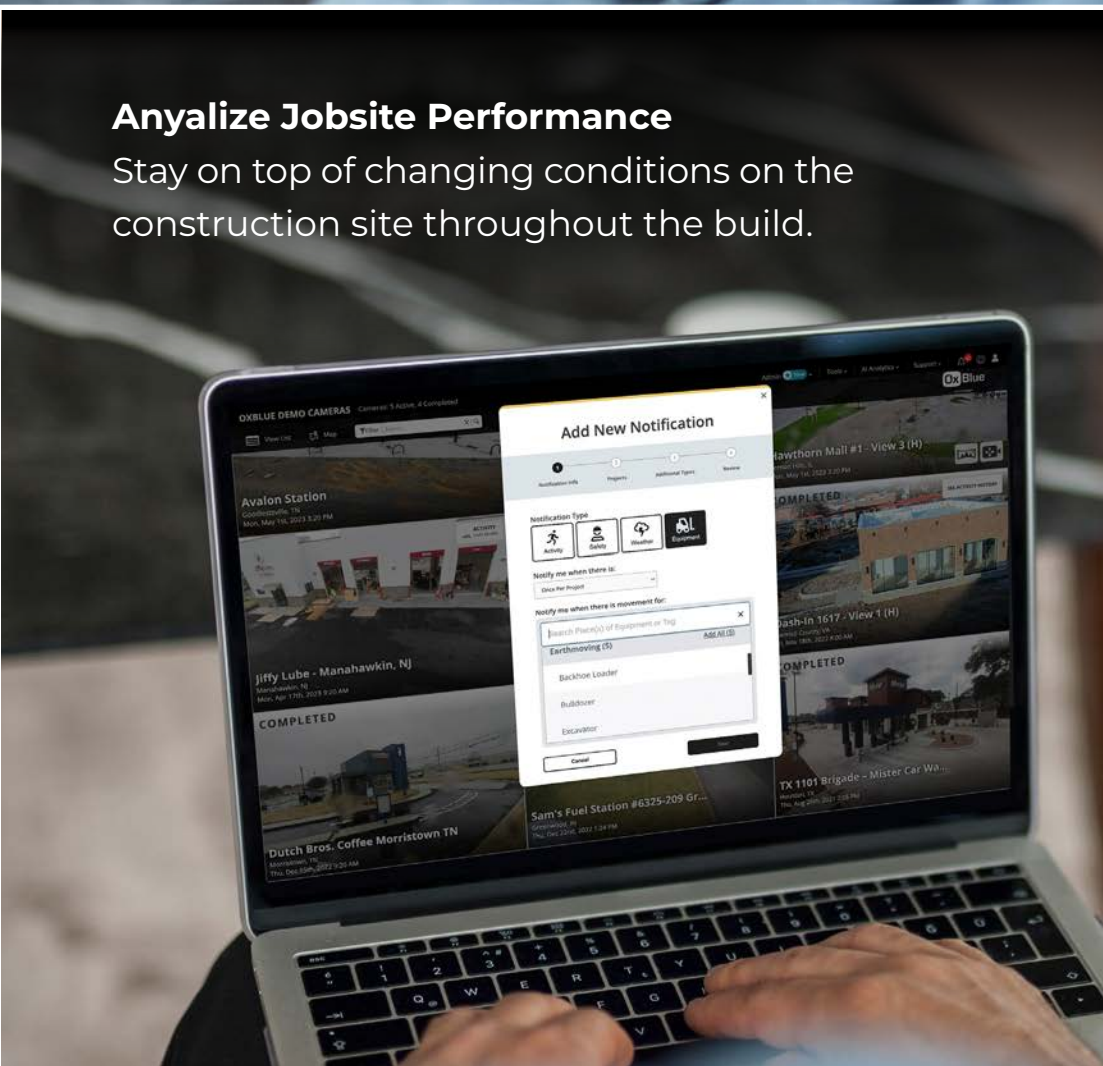

Custom Notifications
 Set activity, safety, and weather alerts so you can quickly identify important priorities and know when your attention is needed on site.

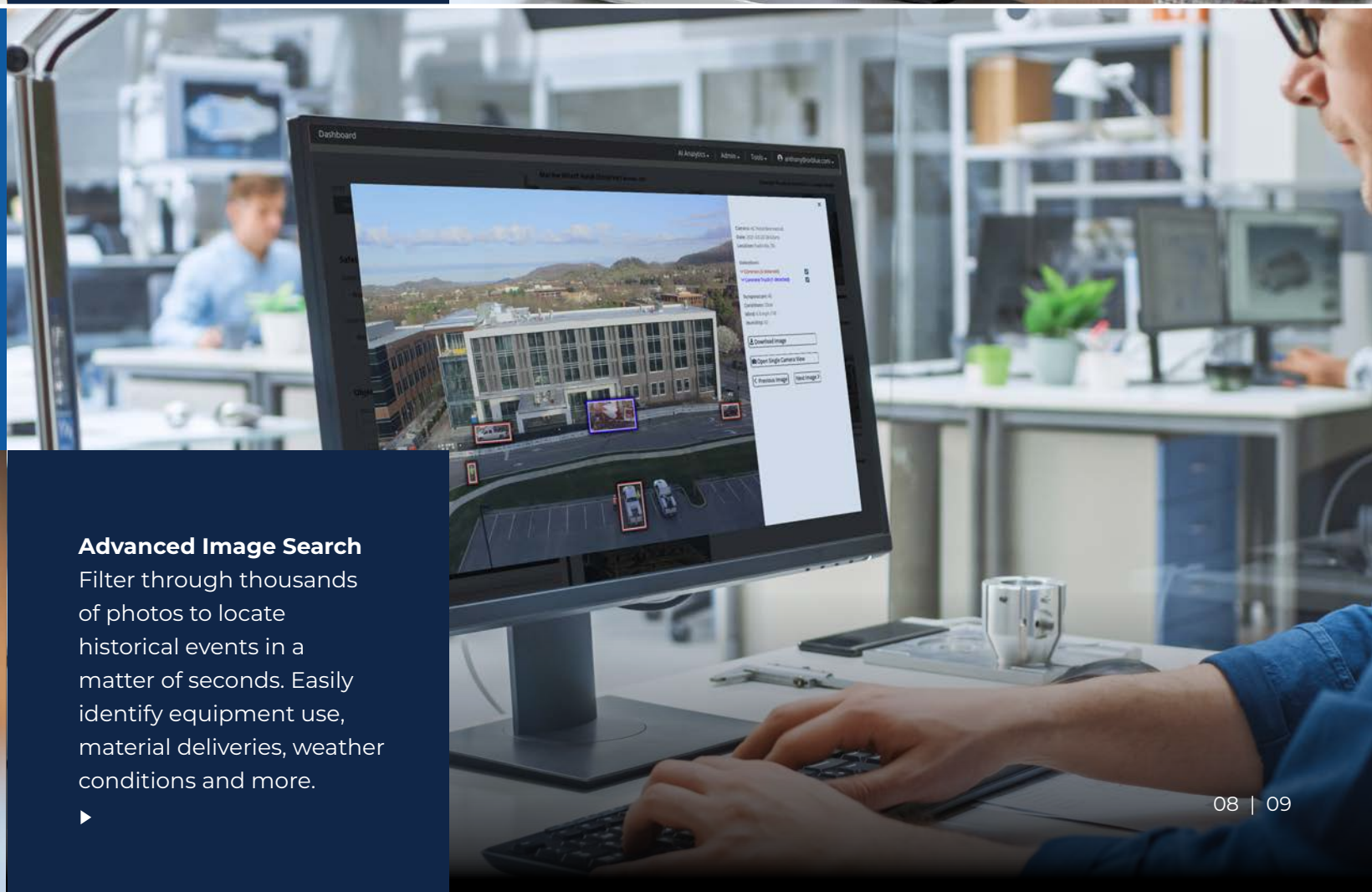

Advanced Image Search
 Filter through thousands of photos to locate historical events in a matter of seconds. Easily identify equipment use, material deliveries, weather conditions and more.

Analyze Jobsite Performance
 Stay on top of changing conditions on the construction site throughout the build.

Safeguard your projects with security monitoring

Reduce risk, combat theft and prevent damages outside normal working hours using OxBlue's security cameras. 24/7 streaming, custom motion detection, automatic documentation and an optional security service helps defend your jobsite from threats.

SECURE

"We were able to use the footage from our OxBlue camera to see what time a break-in happened and capture the make, model and license plate of the car involved."

— Peachtree Hotel Group



Motion Detection

Monitor risk after-hours with Sapphire cameras that use motion detection to automatically alert you to any activity on site with time-stamped video.



Professional Live Monitoring

Add trained agents to review motion alerts and dispatch police if needed.

- UL Certified
- Five Diamond Certified
- TMA Member
- USA-Based Support
- Monthly service charge



Ensure you go to market according to plan

On any given day, project managers and general contractors have a list filled with tasks and small details — taking time and attention away from project priorities.

OxBlue offers an easy way to take control of the jobsite with our advanced construction cameras and visual documentation services. What's captured by a construction camera is a clear, unbiased history of what happens in a day.

“Having on demand access to project information - you can't put a number on that, it's incredibly valuable.”

— Autozone

DOCUMENT

Our time-lapse features and activity analysis serve up key information about the jobsite — detailing an entire day of work in just 30 seconds. The visual record makes it easy to review progress, validate work hours and detect issues that could impact the project.

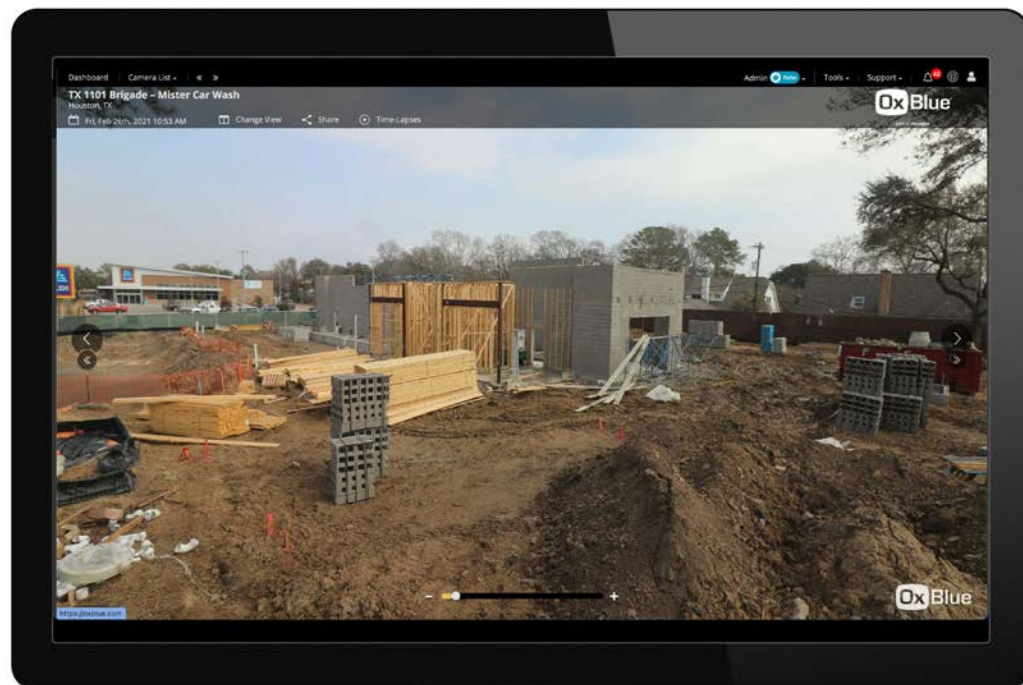



Side-by-side view

Compare multiple jobsites' activity, progress and weather conditions the way you want to



Overlay view

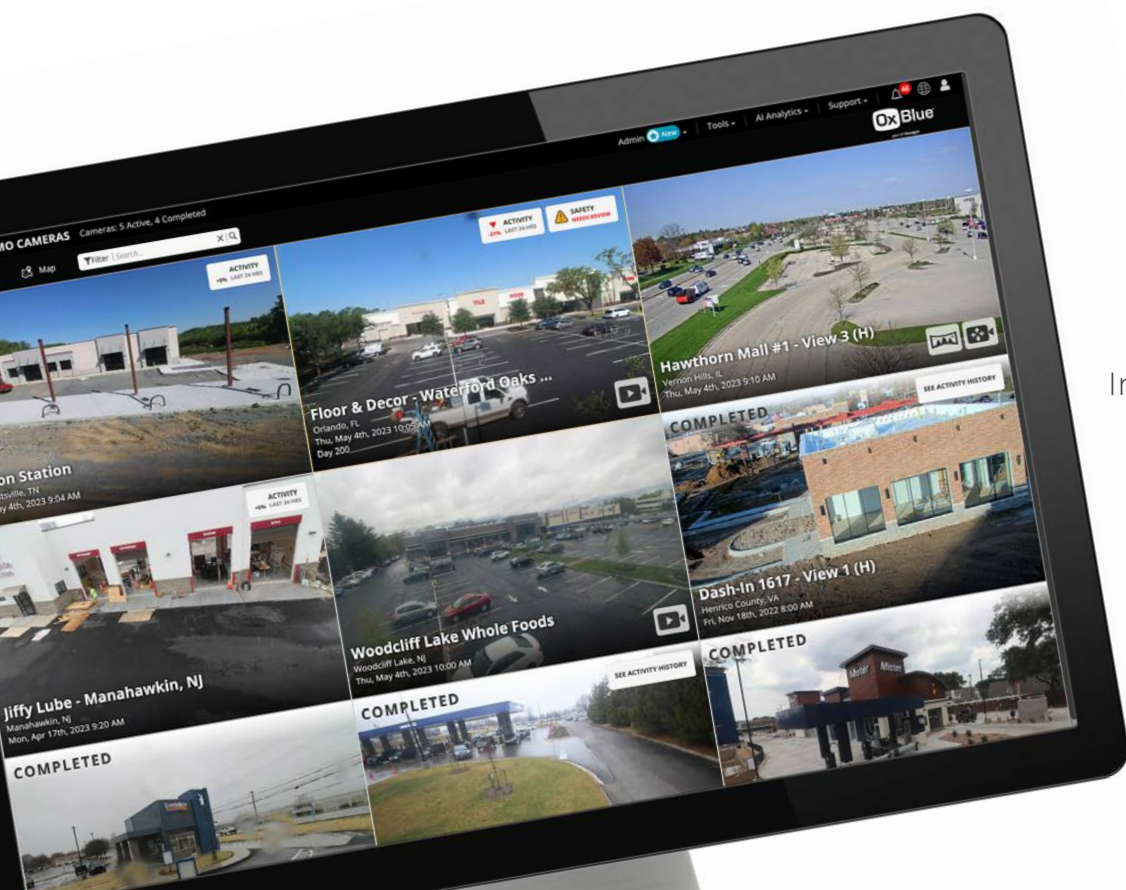
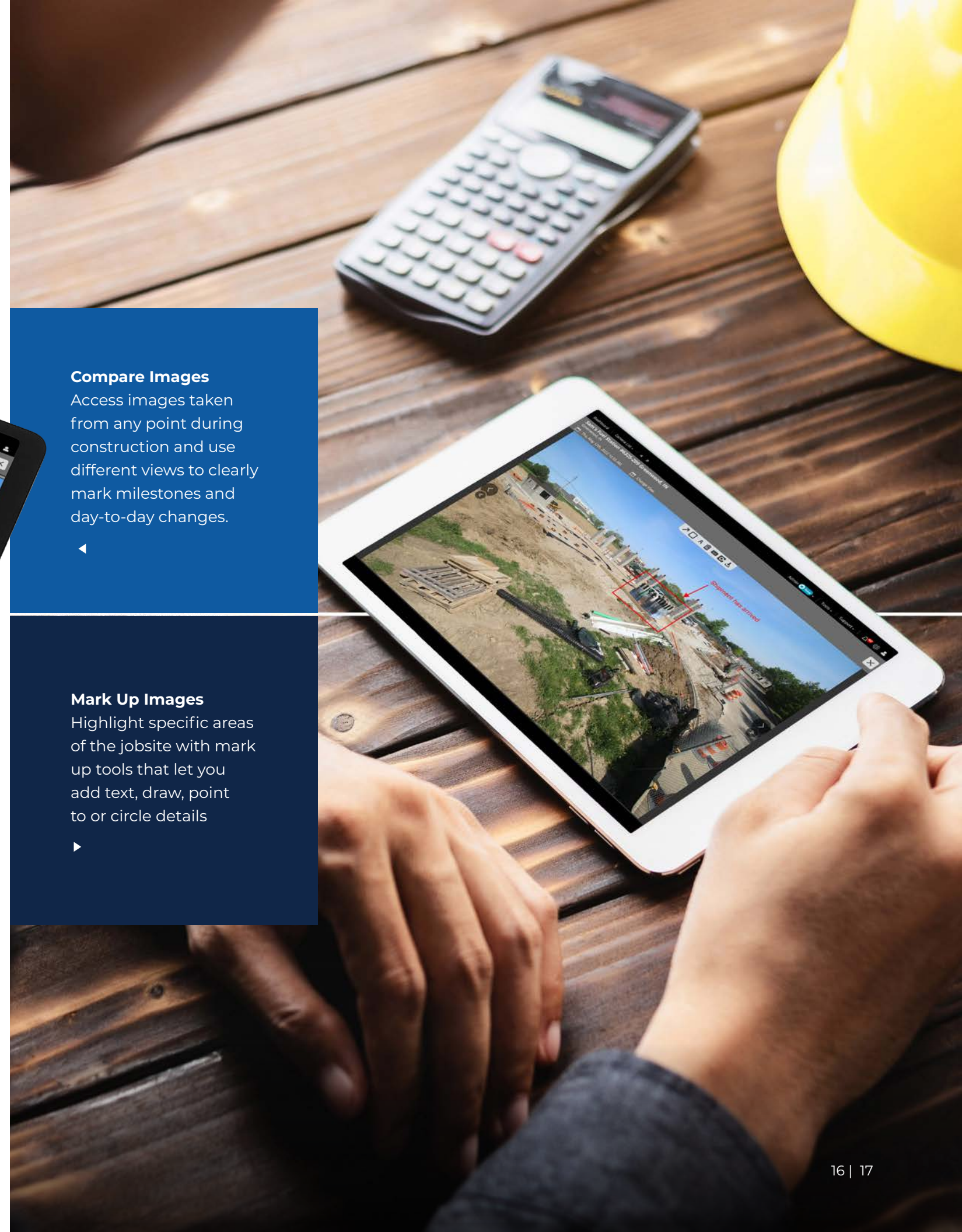

Image gallery view



Compare Images

Access images taken from any point during construction and use different views to clearly mark milestones and day-to-day changes.



Mark Up Images

Highlight specific areas of the jobsite with mark up tools that let you add text, draw, point to or circle details



Showcase your work and strengthen your bidding process

There's more behind the build than just the finished product.

Showing the full story of a successful project means highlighting not only progress, but the data used to outperform the competition. Construction cameras document the details so professionals can visually share results.

MARKET

“The real-time visual access means that we can avoid having anyone, us or the client, reacting to something unexpected on the jobsite.”

— Schimenti

Time-lapse features are powerful marketing tools that share months worth of activity in a beautifully-edited cinematic format. This short video content can capture the attention of an audience on social media, websites and in proposals. It shows the extent of work done on the project and the dramatic results.

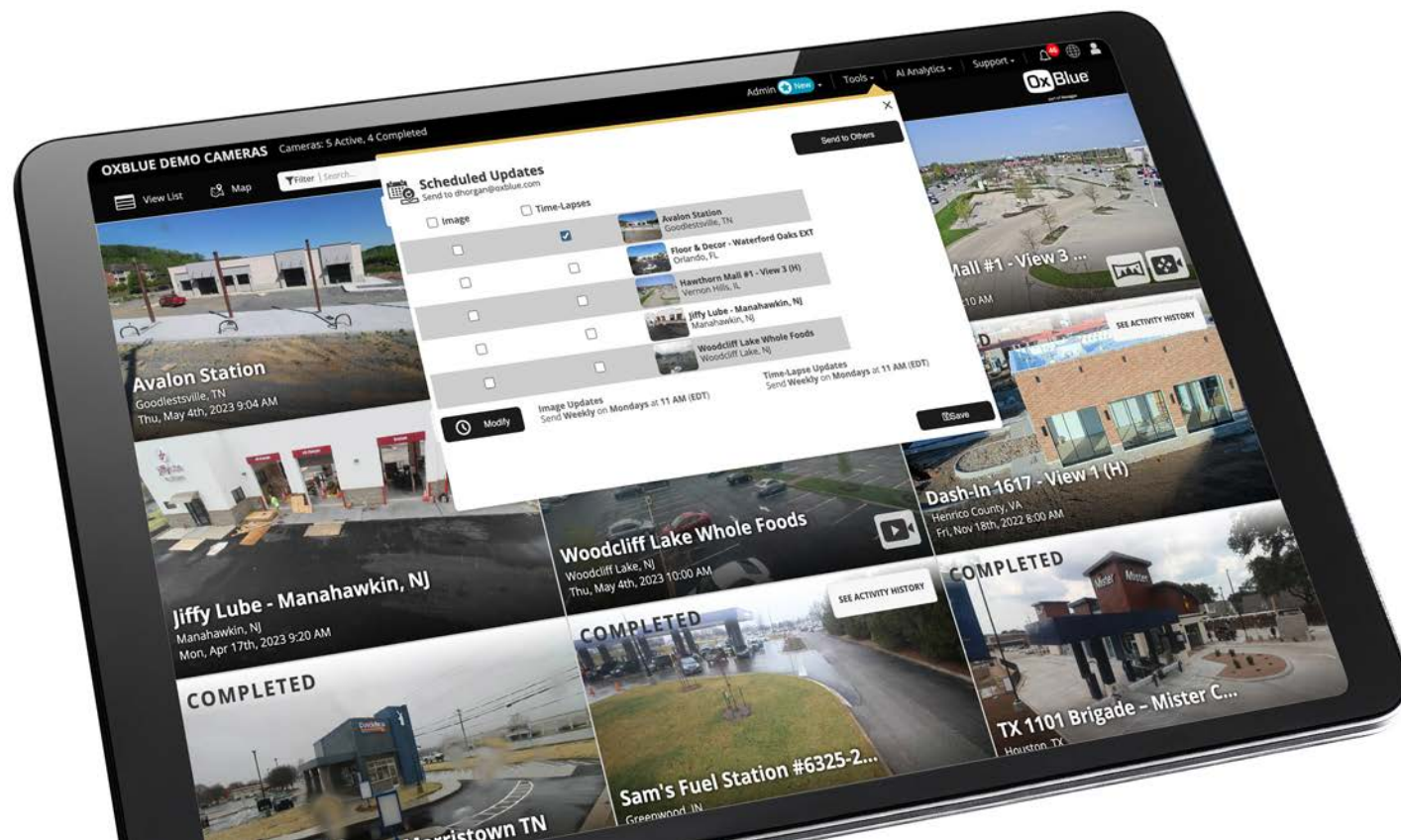

Advertise with Video

Engage prospects with professionally-produced video content that increases awareness of your builds.

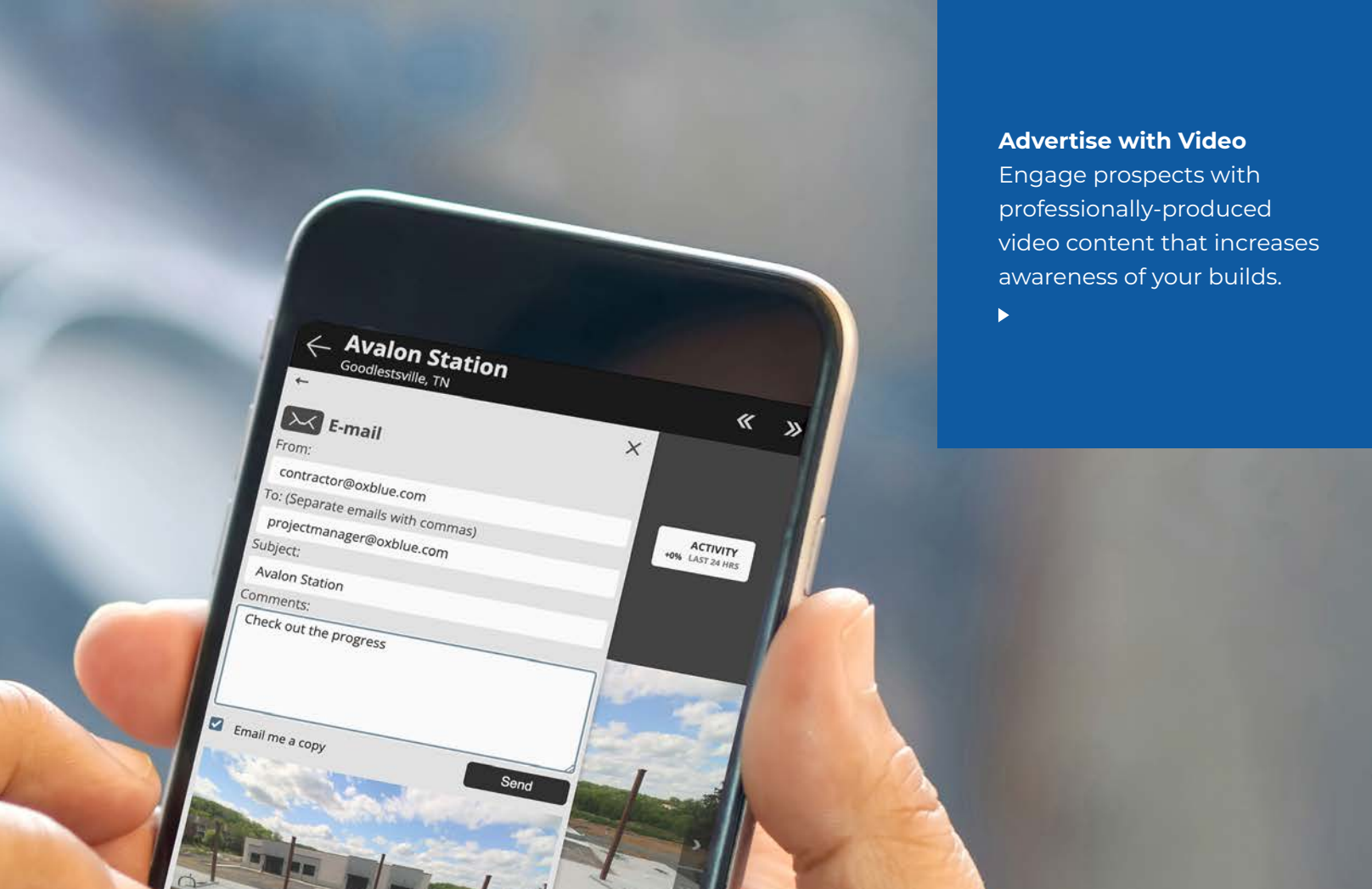

Time-lapse sharing

Highlight Team Progress

Boost your bids by sharing clean construction data that emphasizes team activity, progress and proves the project is always on time and on budget.

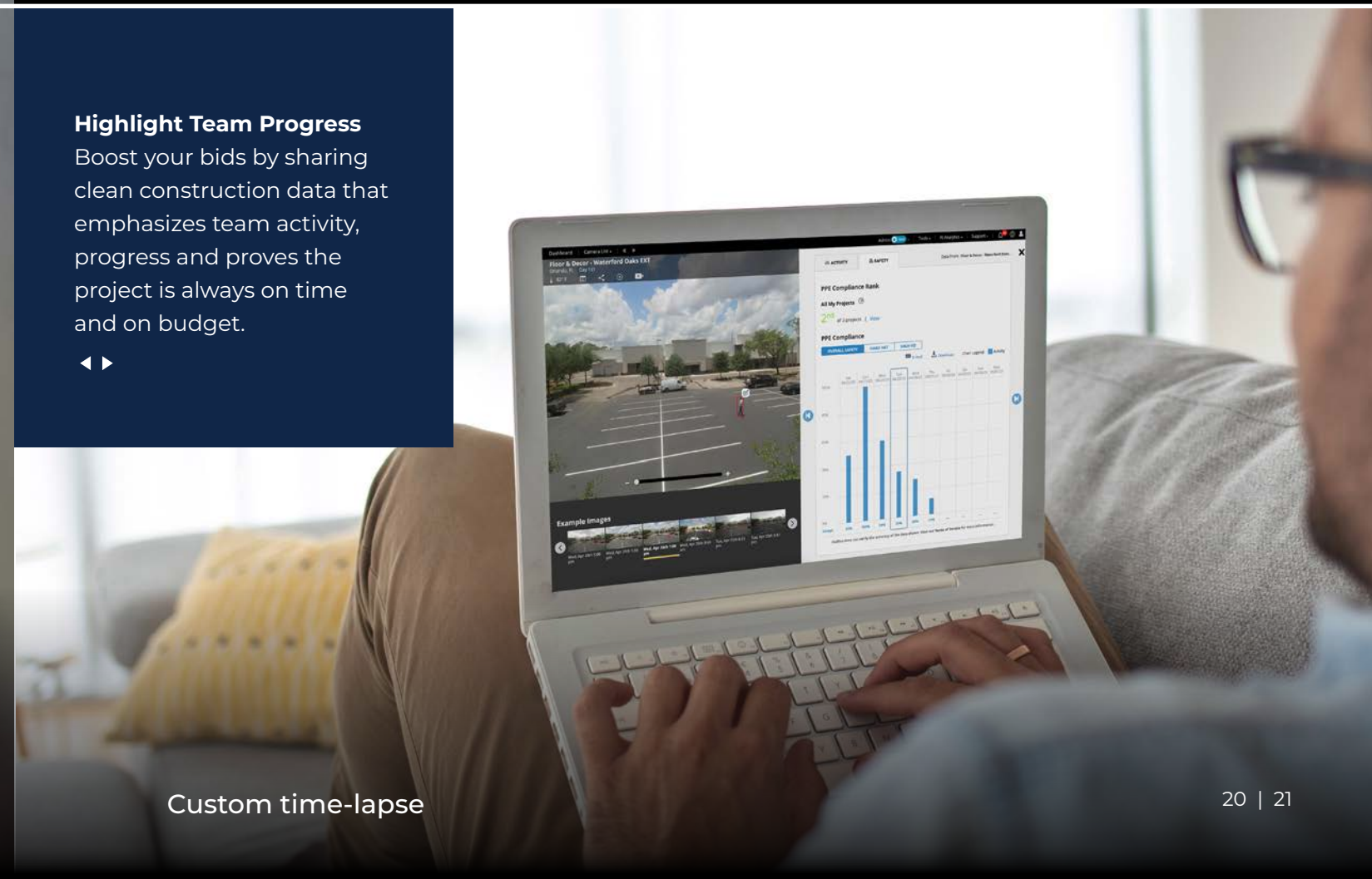

Custom time-lapse



Generate Custom Content
Create time-lapses based on your own parameters to share updates on project progress.



Live streaming your jobsite

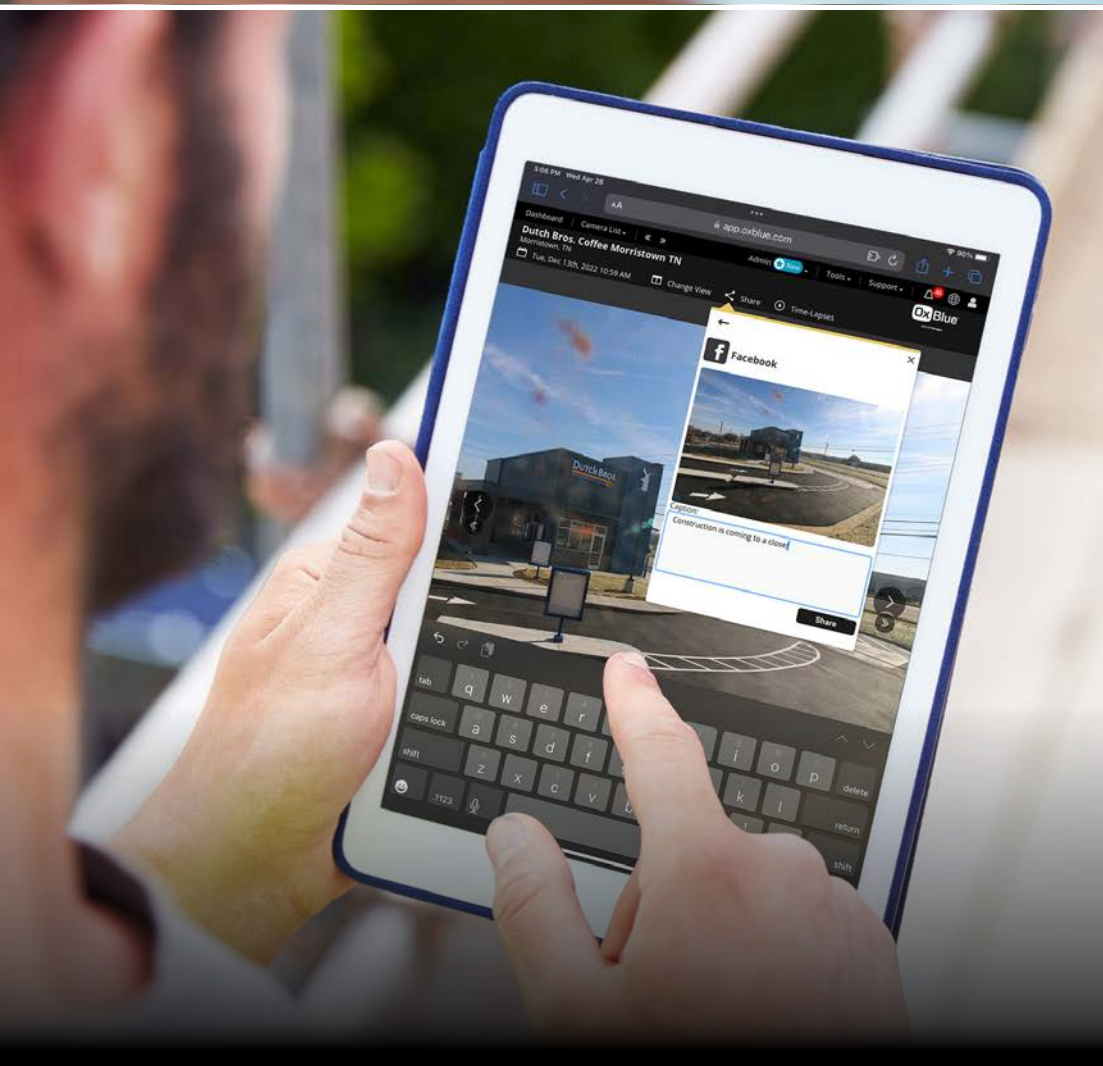

Share to Social Media
Instantly share images, video or time-lapse clips from OxBBlue's web app with just a click.

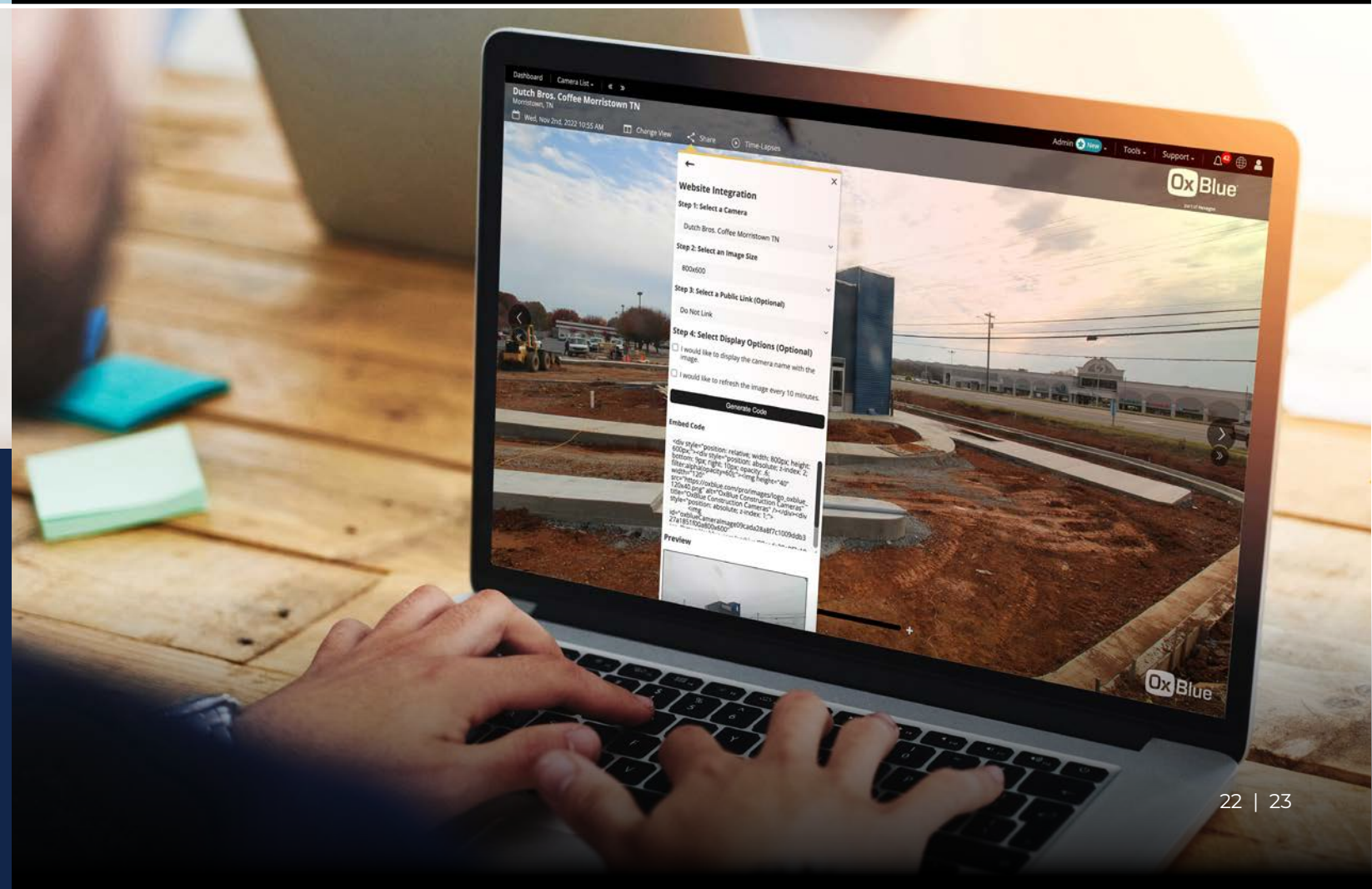



VISUALIZE

Your Job in Plain Sight

Open a new realm of understanding into your jobsite with OxBlue's powerful time-lapse and visual data camera systems.



“We can clearly see what floor the project’s on, what’s complete – you get a much better feel for what’s happening on the jobsite.”

— KDC

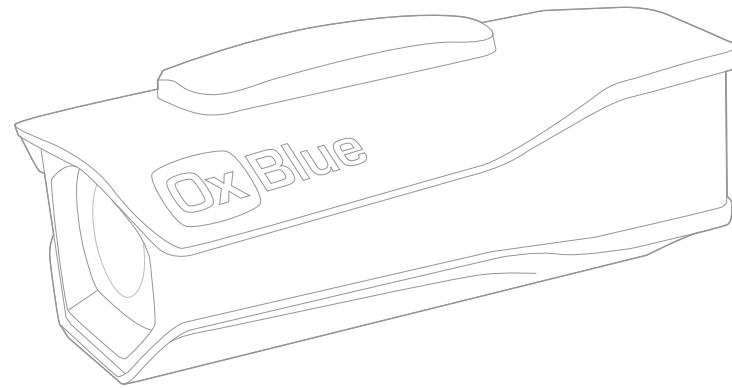

COBALT

Capture high-resolution still images of your jobsite with construction time-lapse cameras that provide detail and insight into your project.

Cobalt cameras are available in 8, 16, 24, and 60 MP models. Consult your rep for the ideal resolution.



60 MP

400% magnification



1,040% magnification

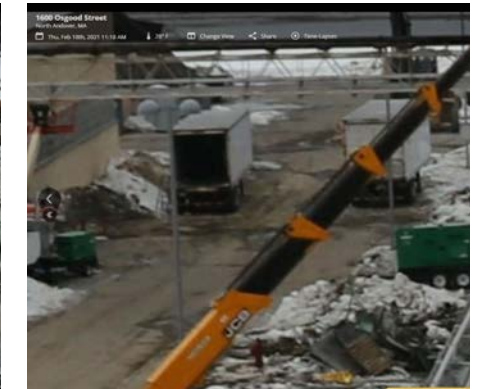

1,640% magnification

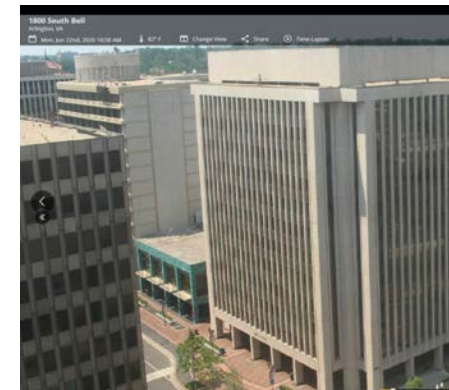

24 MP

160% magnification

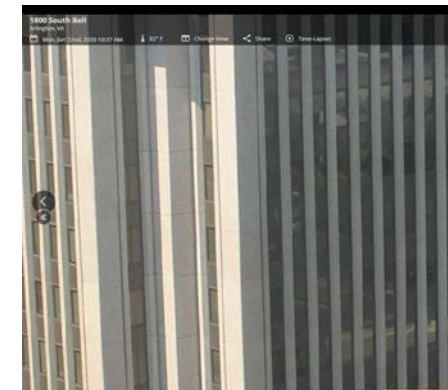

400% magnification

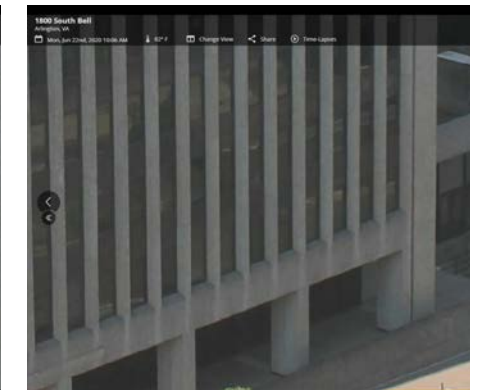

620% magnification



16 MP

160% magnification

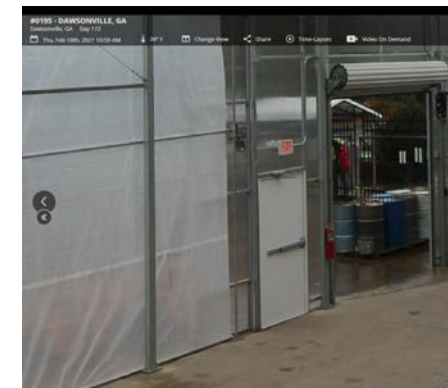

400% magnification

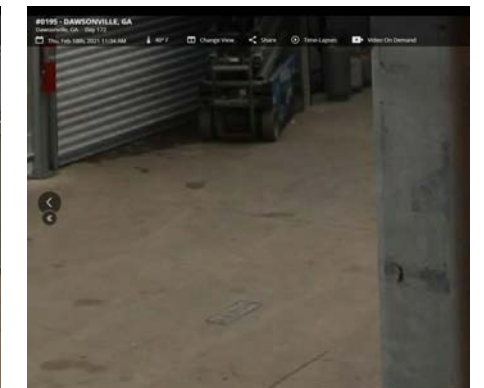

700% magnification

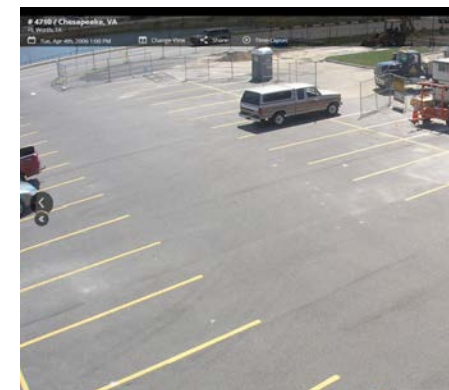

8 MP

160% magnification



400% magnification

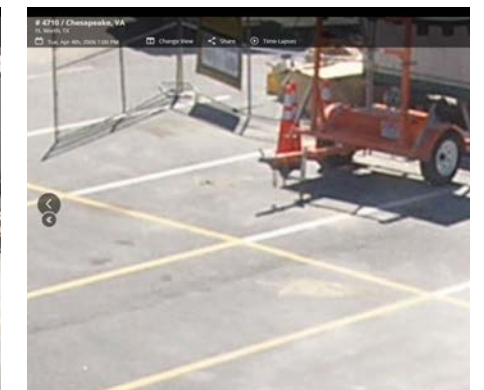

700% magnification

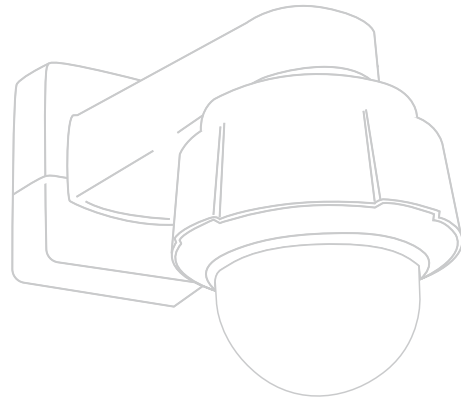

“Roofing is a very dangerous job, so a lot of what we use the camera for is safety. Our managers monitor the images for risks during a project and keep OSHA regulations top of mind.”

— Tremco

SAPPHIRE

See the life of the jobsite with a video camera that gives you live insights into the status of your project.

Sapphire cameras are available in 8 and 4 MP static and, 8 and 2 MP PTZ models. Consult your rep for the ideal resolution.

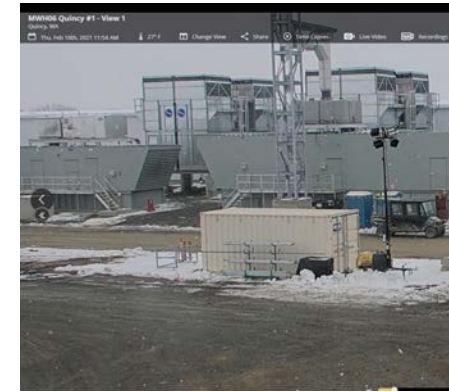

8 MP VPTZ 160% magnification

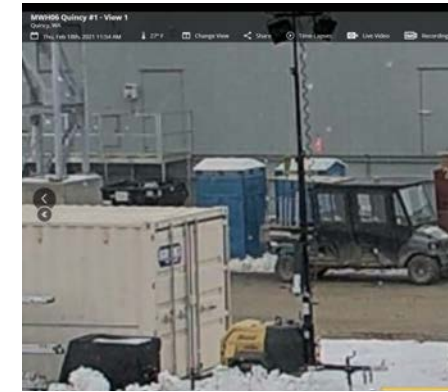

400% magnification

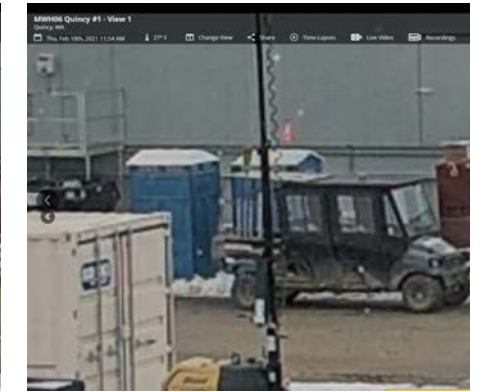

520% magnification

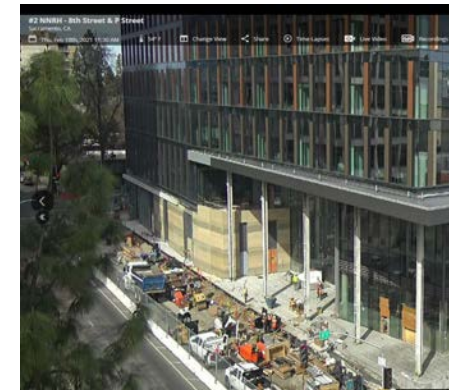

2 MP VPTZ 160% magnification

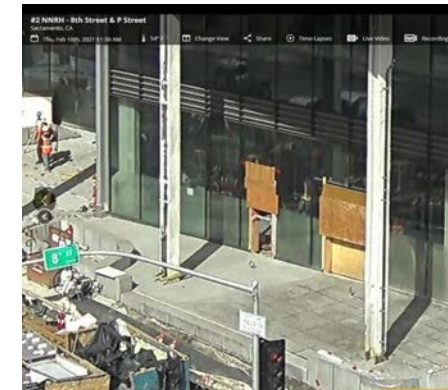

400% magnification

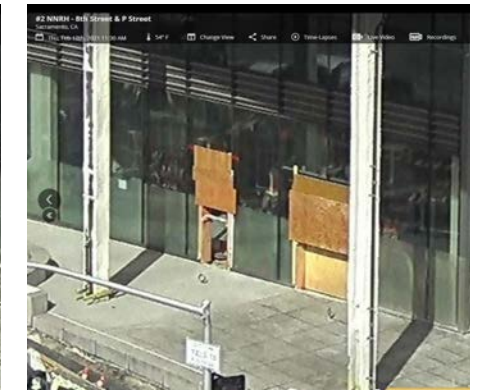

520% magnification



8 MP STATIC 160% magnification



400% magnification



520% magnification

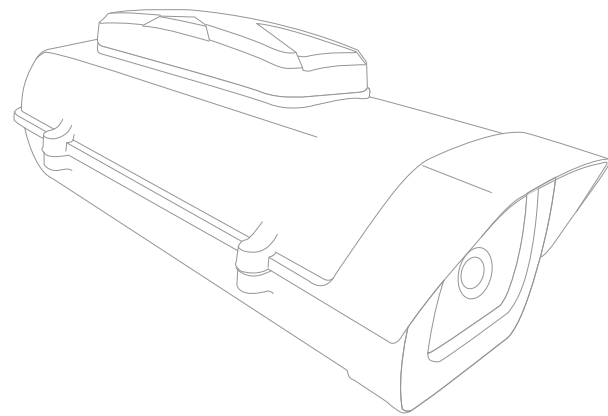

“The OxBlue Team was very responsive, attentive and proactive throughout the entire project. OxBlue operates with professional customer service and has high quality products.”

— Clark Construction

INDIGO

Reduce the need to be on site for your interior projects with an expanded field of view and the ability to pan and zoom within photos.

Indigo cameras are available in 8, 12, and 16 MP models. Consult your rep for the ideal resolution.

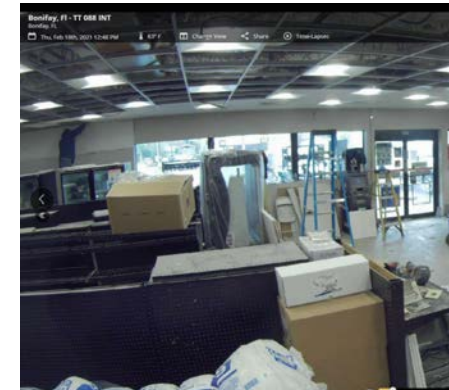

16 MP

160% magnification

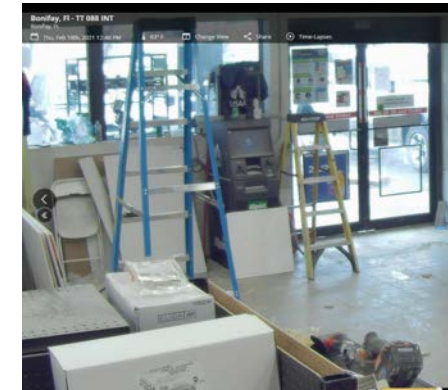

400% magnification

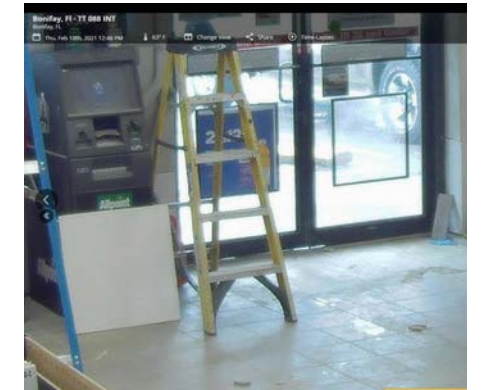

700% magnification

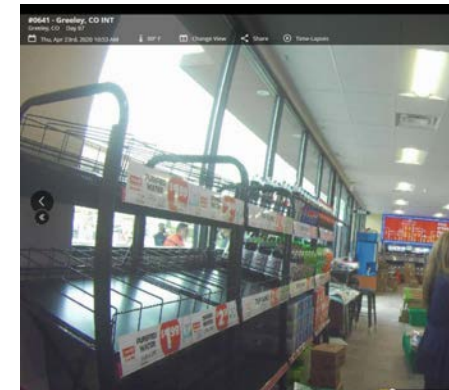

12 MP

160% magnification

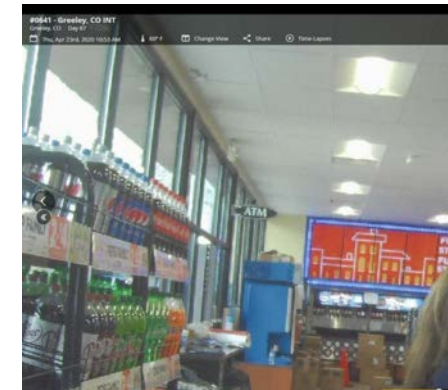

400% magnification

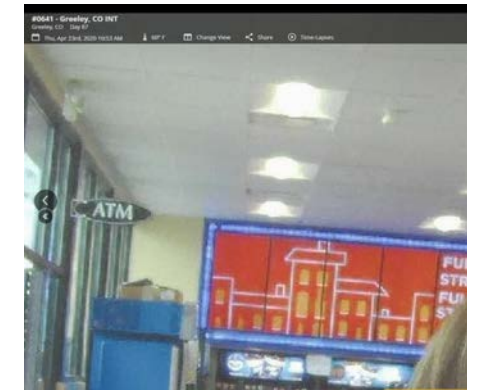

620% magnification

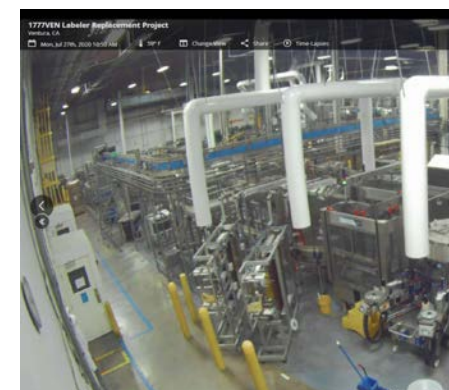

8 MP

160% magnification

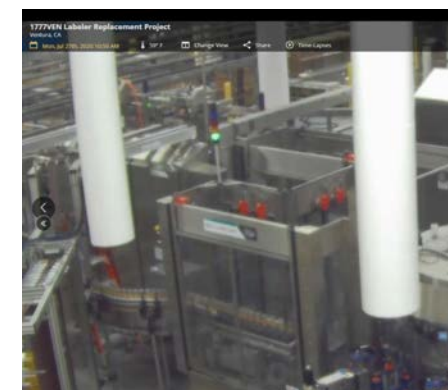

400% magnification



700% magnification

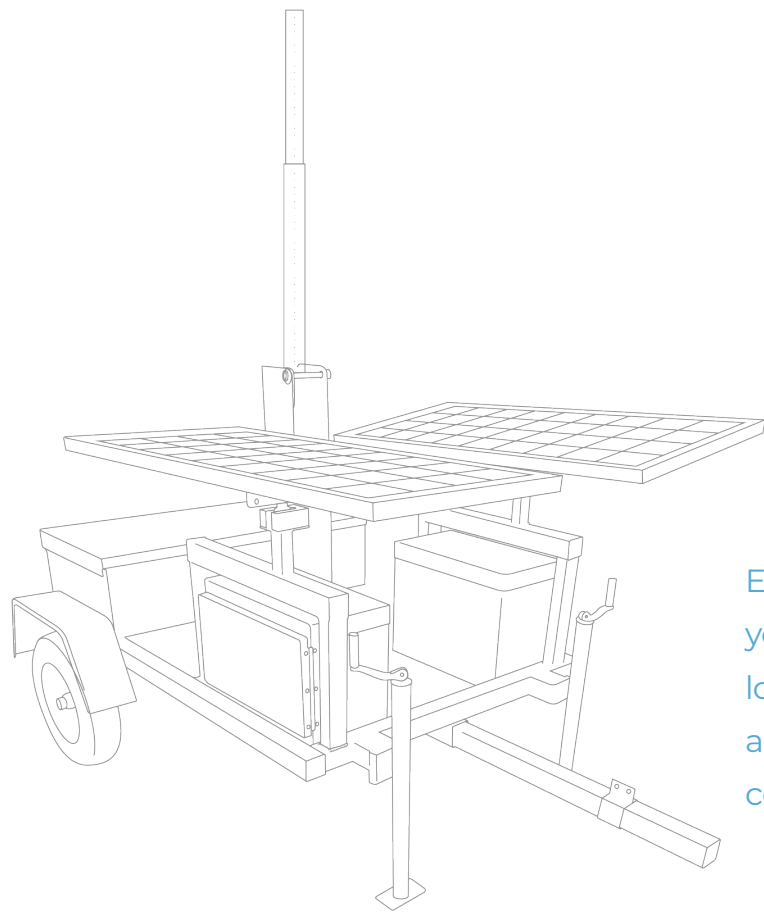

Ensure your camera is always monitoring your project, even in the most remote locations. OxBlue's portable solar trailers and solar power stations are ready to connect you to the jobsite.

SOLAR

Designed specifically for OxBlue cameras, solar is available in a variety of dimensions based on your needs. All solar options typically qualify for a 26% federal tax credit for renewable energy products.



Solar Station



Solar Trailer

SEE THE STORY BEHIND YOUR JOBSITE WITH OXBLUE



part of Hexagon